

PLATFORM CAPABILITIES

ABOUT CLOUDSIGMA

1. Swiss company founded in **2009**, currently with just over 50 employees.
2. Leading **IaaS provider** with a focus on **flexibility & performance**.
3. Built our **own cloud stack** allowing a unique and highly flexible service offering.
4. A **100% local infrastructure** solution.
5. A **global** network of locations.
6. Direct connectivity to **GÉANT & De-CIX**.



CLOUDSIGMA AT A GLANCE



CERTIFICATES AND COMPLIANCES

ISO 27001

CERTIFIED

Information Security

ISO 27017

CERTIFIED

Cloud Security

ISO 27018

CERTIFIED

Privacy Protection



CLOUD PLATFORM CAPABILITIES



WHY CLOUDSIGMA IS THE PARTNER TO CHOOSE



Swiss Cloud with Global Deployment Options

Offer cloud, data center and managed services to customers worldwide.



High Security

CloudSigma is ISO-27001 certified and PCI-DSS compliant. We deliver a high degree of security in accordance to various aspects of computing.



24x7 Free Technical Support

Our friendly customer support is available 24x7 and our escalation policy ensures the rapid resolution of all issues.



Public, virtual private & hybrid cloud options

Offer your customers the full spectrum of infrastructure options on top of your services.

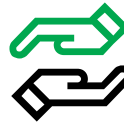

Compliance

Choose the most appropriate national legal framework under which to run customer cloud computing infrastructure.

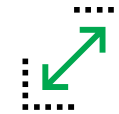

Flexibility & Compatibility

Any x86 OS or application can run in our cloud unmodified. Resources are not bundled together and there is no 'standard size' server.



Reliability and strict SLA

CloudSigma guarantees 100% availability of virtual servers and network backed up by strict SLA of x50 times credits against any downtime over 15 minutes.



Flexible and Transparent Billing

Combine long-term subscriptions for predictable workloads with on-demand scalability for unplanned capacity. Offer customers best price-performance ratio.



Value-added Cloud Services

Deploy DRaaS, security features, load balancing, DDoS mitigation and more.

TRUSTED BY INDUSTRY LEADERS...

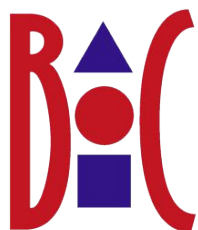

...AND ACADEMIC PARTNERS



Sheffield
Hallam
University

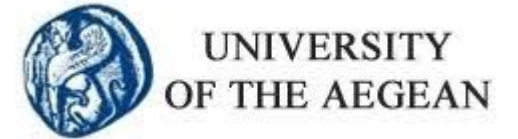

UNIVERSITY OF
WESTMINSTER 冊



National Technical
University of Athens



SUCCESS STORIES



Why they chose CloudSigma?

- Variety of storage options
- Seamless migration of large volumes
- High price-performance ratio
- Flexible on-demand scalability
- Elastically scale-up resources
- Excellent customer service

Customer Profile

Digital Asset Management platform, offering private shared libraries of professional photos, films, graphics, documents and other media.

The Challenge

SQL server cluster, requiring high disk IOPS and network throughput as well as superior CPU and RAM performance.

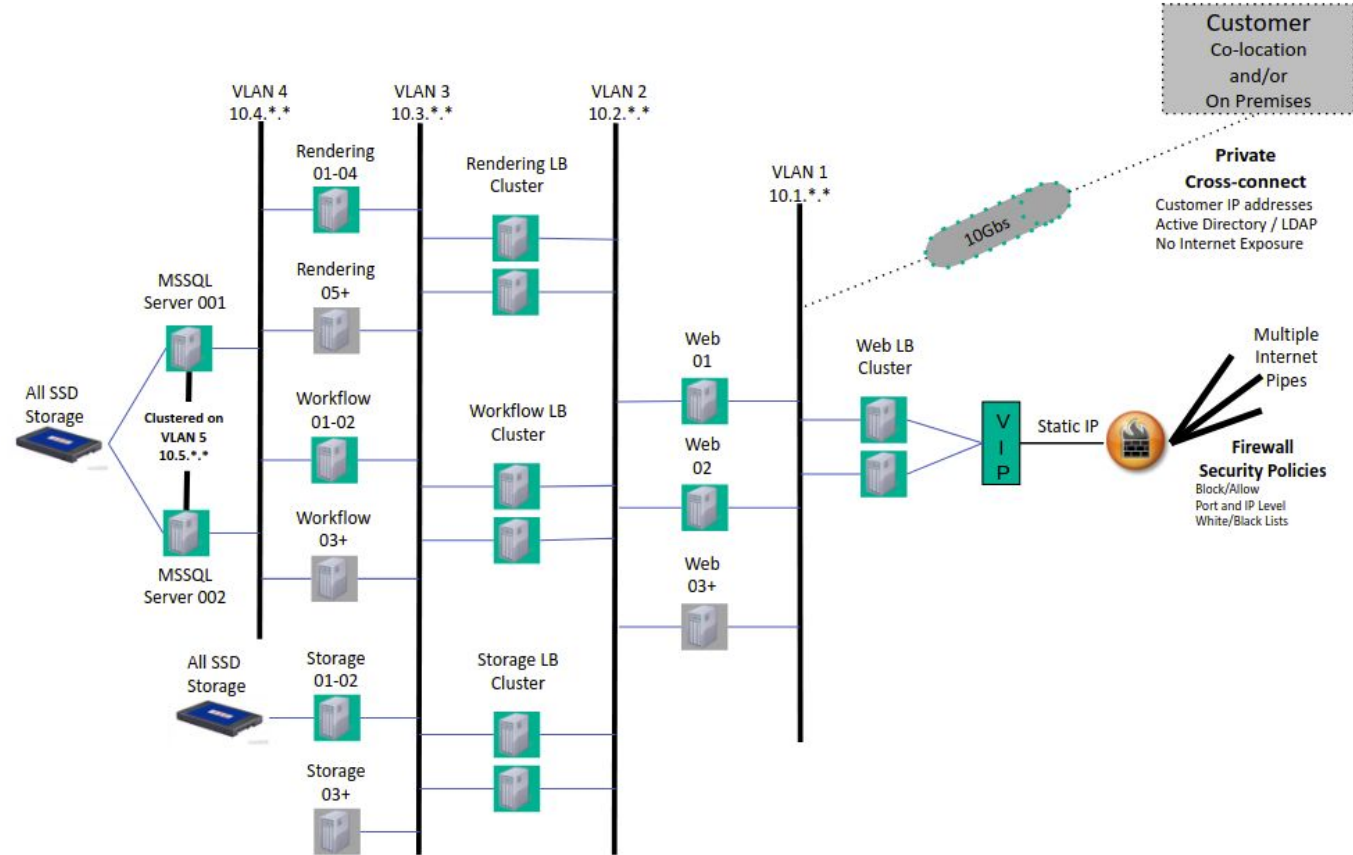

“Having one partner for everything, with a choice of locations, to be able to be closer to the customers and provide better performance, allows us to better able to serve customers.”

Why they chose CloudSigma?

- Data security & privacy
- European cloud
- Scalability
- ISO 27001 / PCI-DSS compliance

Customer Profile

Healthcare Research Institute is part of Swiss Post Healthcare Solutions. It is a platform which processes analysis, medical surveys, studies and registries.

The Challenge

On-demand scalability, yet highest level of security and data privacy due to the work with sensitive patients' data.

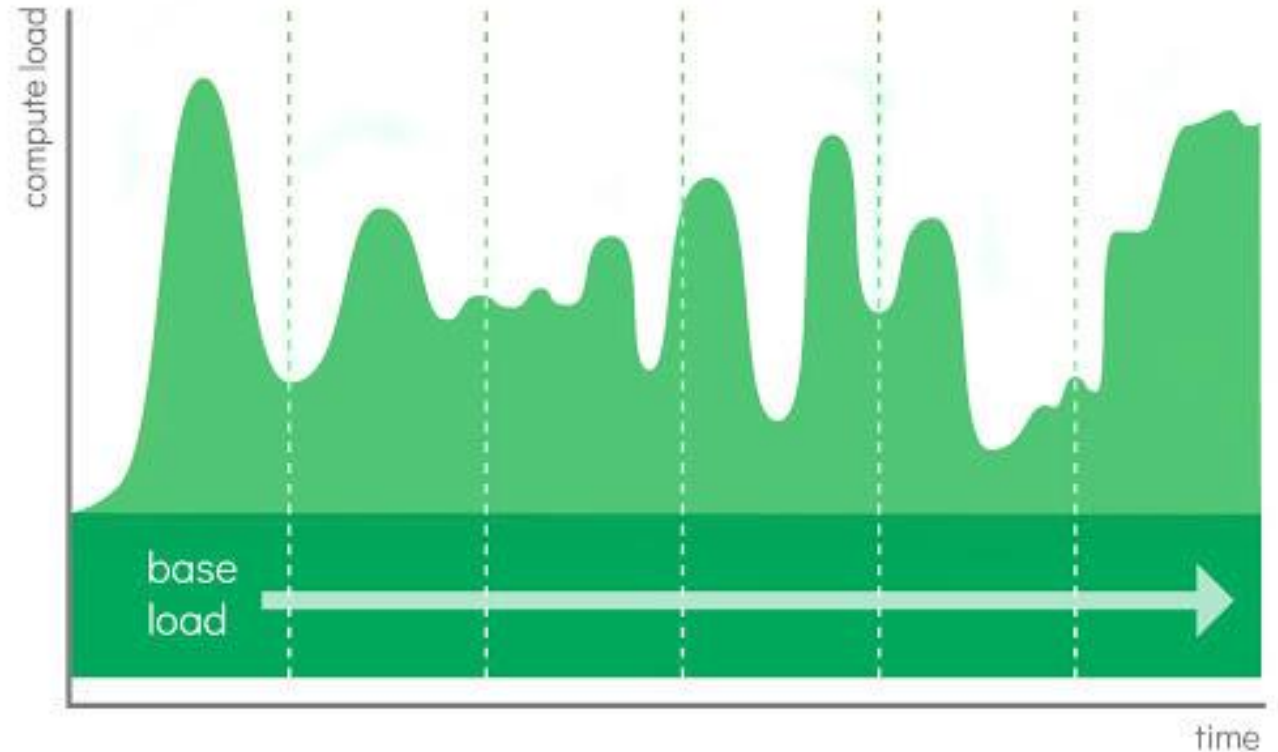

“When we talk about patients’ data, data privacy is of utmost importance. At the same time, we wanted to be flexible on the infrastructure side. In the face of CloudSigma we found the ideal partner for all our needs.”



Why they chose CloudSigma?

- Flexible resources
- Variety of storage options
- Excellent customer service
- Performance & availability
- European company
- Low latency

Customer Profile

We work with the Research and Support Service (RSS) of the European Space Agency (ESA). ESA RSS provides resources to support Earth Observation data exploitation.

The Challenge

Host a web based process where scientists around the globe can request on-the-fly processing of ESA satellite data from the Volcano and Earthquake supersites.

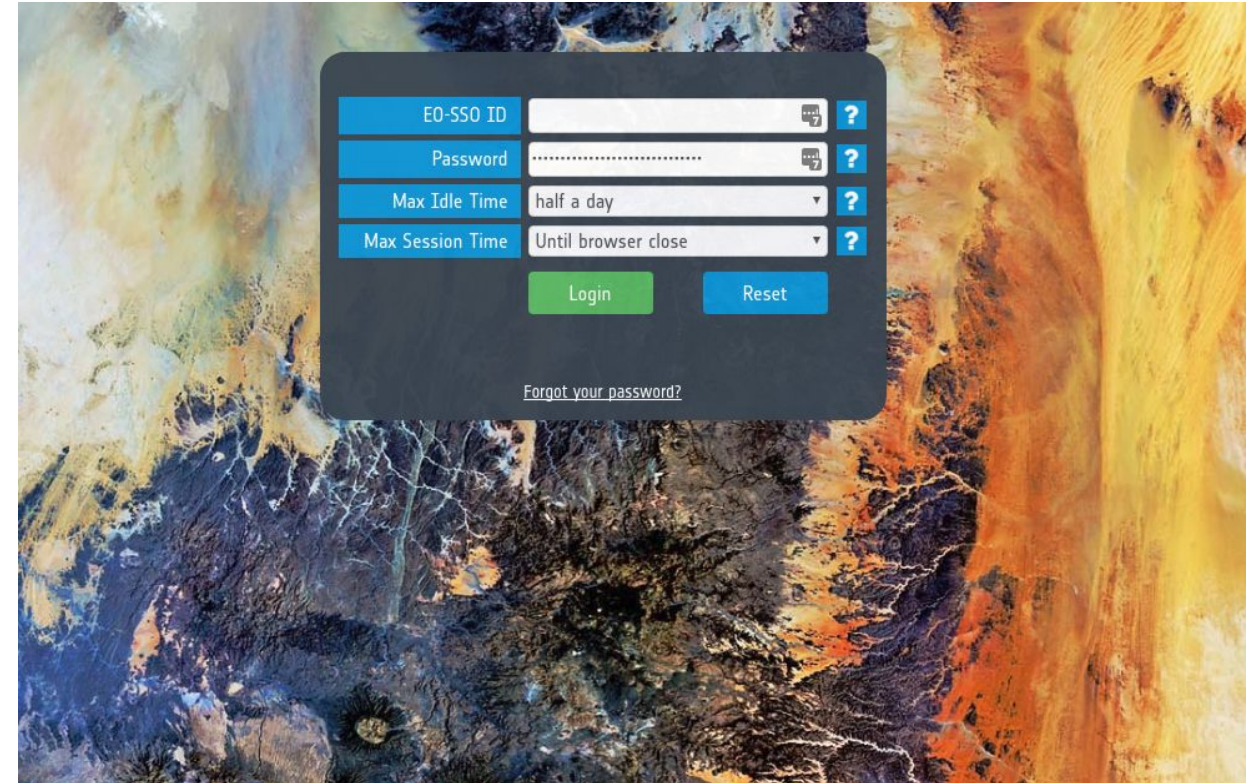

“By having our choice of good performance, cost effective storage or high-performance SSD storage, all of which is elastic and on-demand, we’re able to quickly and cost effectively deploy our platform.”

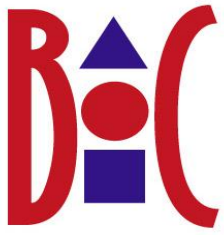

Why they chose CloudSigma?

- Flexible Networking
- Persistent performance
- No vendor lock-in
- Excellent technical support
- European company
- Global operations

Customer Profile

An internationally leading manufacturer of software tools for globally recognised management approaches.

The Challenge

Move SaaS operations from on-prem to the cloud without the dependence on proprietary solutions.

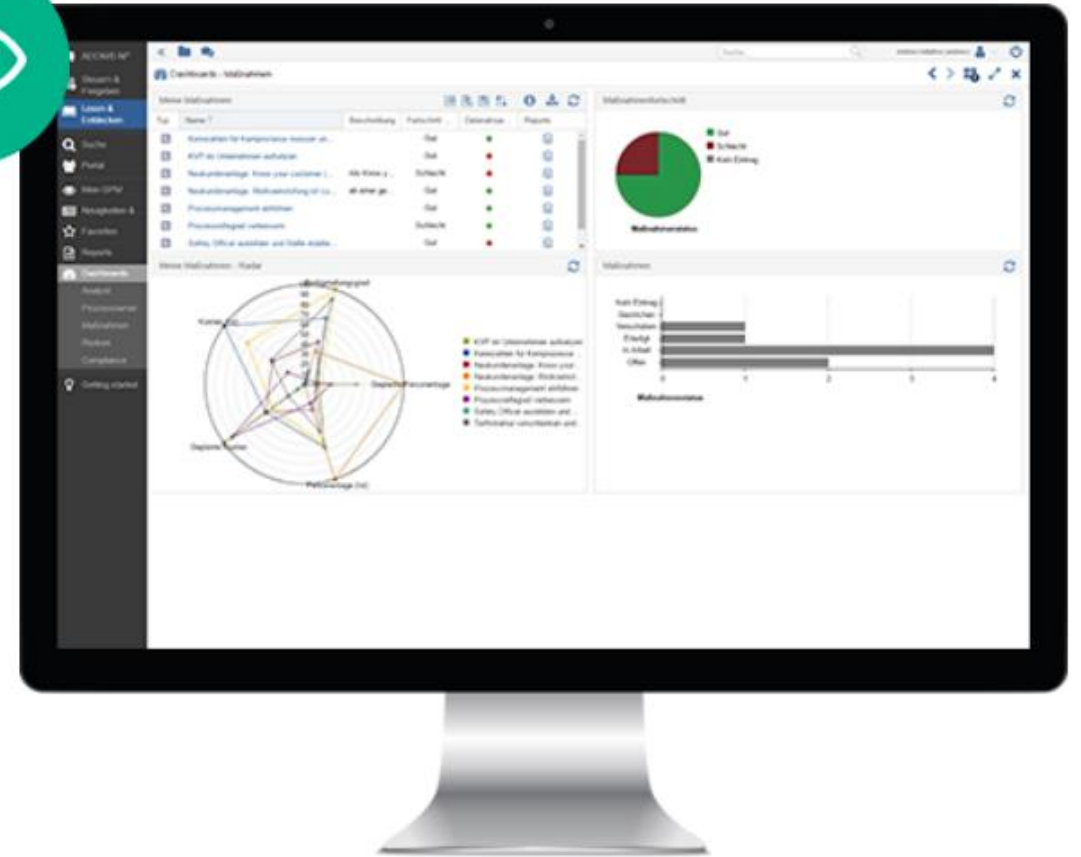

“Designing and implementing our architecture on the CloudSigma platform serves our exact needs and allows us to grow our cloud service portfolio really fast and efficiently.”



GET YOUR FREE EVALUATION ACCOUNT

YOU WILL RECEIVE:

- A demo session with a dedicated Account manager
- Up to 1 month Evaluation period to test the platform performance and take advantage of our free 24X7 Support

[SIGN UP NOW](#)